



Byworth
BOILERS
Steam
Export Brochure



byworth.co.uk





"I am writing as a businessman for businessmen"

Dennis Baldwin, 1990, in his book "Soil sterilisation using steam".

Dennis Baldwin, Founder of Byworth Boilers. Dennis used steam to heat his commercial greenhouses where he grew Chrysanthemums.



Our Story

Dennis Baldwin – the customer turned entrepreneur - the essence of our brand and our heritage.

Byworth was founded in 1968 by Dennis Baldwin. Dennis became a well-established chrysanthemum and tomato grower. The entrepreneur ran his own successful business from the young age of 17.

Based on 3 sites around Yorkshire, Dennis used steam boilers to heat his 3 acres of glasshouses.











He came from a long line of engineers and with that inherent talent, he decided to design and install his own heating and boiler systems. Soon after, other horticultural businesses were recognising his flair for producing high-quality steam boilers and the demand for his products rose. With two sons more interested in engineering than growing, Dennis took the

brave decision (aged 42) to make a career change. He sold his successful horticultural company to finance a land investment to set up a factory. This was when Dennis Baldwin & Sons boiler manufacturers were first established; later to be known as Byworth Boilers. They supplied steam boilers, not only to growers but to other industries as well.

Dennis was able to build a product that better suited the needs of his industry. These values remain today as Byworth seek to produce solutions that fit the customer's requirements, never offering a 'one size' fits all. We understand the challenges organisations often face, and our team of experts will work in partnership with you to deliver solutions that better support your individual needs.

Our Customers

Today we serve a diverse range of customers, big and small, in a multitude of industries including:

-  Food
-  Beverage
-  Healthcare
-  Paper and Packaging
-  Pharmaceutical
-  Architecture/M&E/Civil Engineering
-  Petrochemical
-  Animal Feeds & Farming
-  Laundries
-  Textiles



Your Guide

Conventional Steam Boilers

The M-Series Range

These compact boilers are perfect for smaller applications and those who are new to steam. The range includes our space-saving, skid-mounted, all-in-one solution with everything you'll need for a quick and easy installation.

Pages 5 - 8

The Peaksman Range

The Peaksman vertical steam boiler delivers Ultra Low NOx emissions in 125 kg/hr to 1000 kg/hr F&A 100°C steam outputs. In spaces where our market leading

M-Series horizontal steam boiler would be impractical, the compact Peaksman vertical steam boiler is a perfect fit, offering modulating controls as standard alongside automatic TDS and bottom blowdown systems.

Pages 9 - 12

The Yorkshireman Range

With a high degree of reliability, low emissions and high efficiency, the Yorkshireman, three-pass, wet-back boilers are the workhorse of industry.

Pages 13 - 16

Heat Recovery Range

Our waste heat boilers offer enhanced efficiency by producing steam using heat recovered from other processes that would otherwise be wasted.

Pages 17-18

Economisers

New and old boilers alike will benefit from reduced fuel consumption by installing one of these two technologies. Heat is recovered from the boilers own waste gases to heat either the boiler feedwater or combustion air.

Pages 19-20

Other Products

You may also need:

Boiler Houses

We offer a range of boiler-housing options from prefabricated, "plug & play" boiler houses, through to full on-site construction of larger buildings.

Pages 21-26

Accumulators

Remove the peaks and troughs from your steam demand with a custom-made steam storage vessel.

Pages 27-28

Hotwells, Deaerators & Blowdown Vessels

Hotwell tanks and deaerators are essential to capture returning condensate, and provide a strategic store of hot, treated water for the boiler. Blowdown vessels provide a safe means of cooling waste water from the boiler before discharging it to drain.

Pages 29-32

Burners - Did you know...

...We work with all the leading manufacturers to ensure we offer you the right burner to meet your unique needs.





M-SERIES

Compact horizontal boiler for light to medium steam load.

Sizes: from 250 – 5,000 kg/hr
Working pressure: up to 13.8 bar g

Made exclusively in the UK, the Byworth M-Series is the popular option for small to medium applications. Robust, reliable and designed for long-term ease of maintenance; the M-Series range is the smart choice for those who need a little more steam storage or drier steam than typically offered by vertical solutions.

The M-Series is all about getting the basics right so you can focus on delivering your customers' needs.

The ideal balance between efficiency and size

Suitable for a wide range of liquid or gaseous fuels including natural gas, LPG, LNG, biogas and heating oils

Lightweight, hinged front-door

Removable rear doors

Spiral wound turbulators significantly improve efficiency without increasing the boiler footprint

Available as a compact, skid-mounted option for the those with limited space

A wide range of upgrades are available including efficiency enhancements and controls for unattended operation

*Applies to boiler range 1500kg and above

Reduced Downtime

The M-Series has design advantages such as a lightweight, hinged front door, weld inspection panels and removable doors; creating an ease of maintenance for any engineer or inspector. This reduces downtime significantly during cleaning, maintenance and inspection

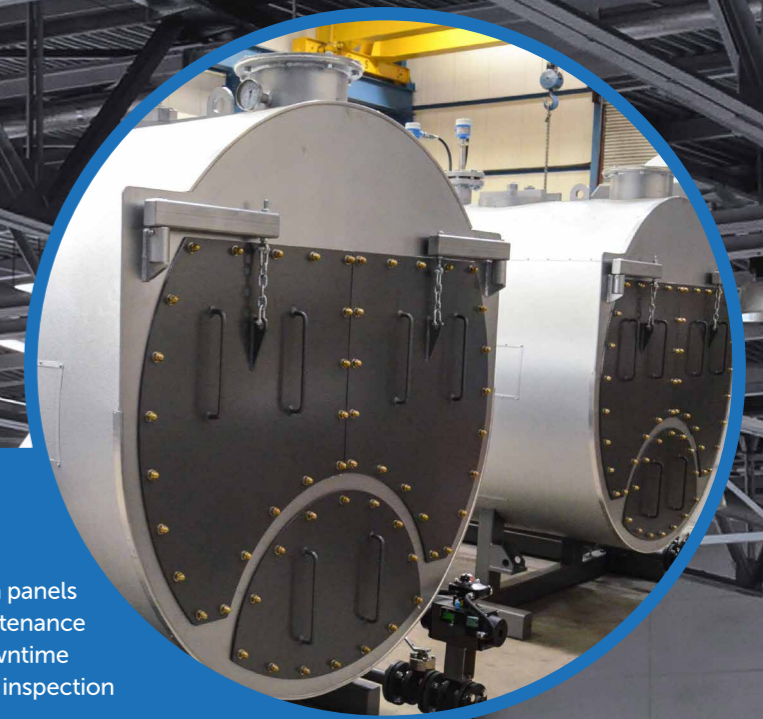



The M-Series Dimensions

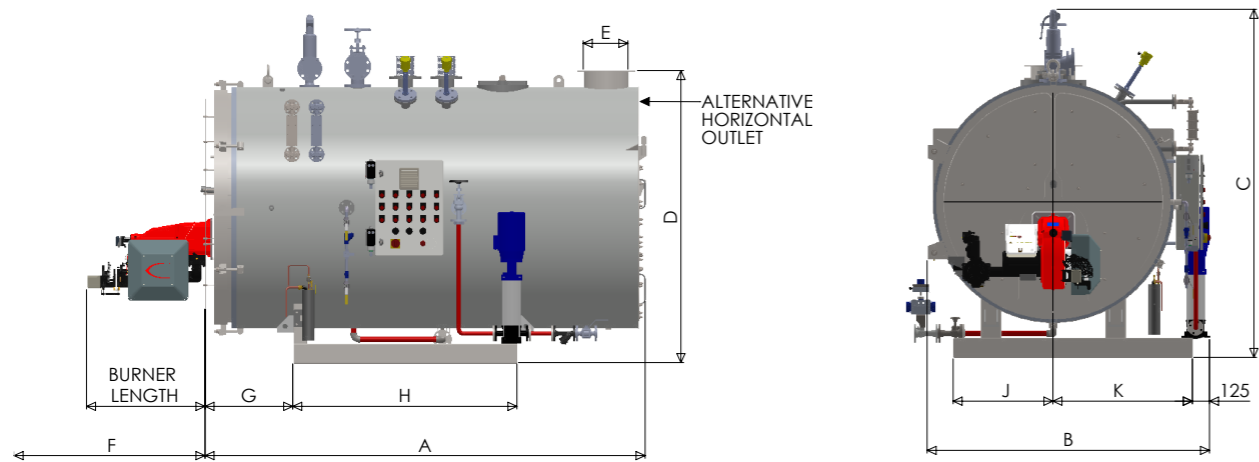

M-SERIES - BOILER DIMENSIONS

Model MX	250	500	1000	1360	1500LN	2000LN	2500LN	3000LN	3500LN	4000LN	5000LN	
Duty F & A 100°C	lb/hr	500	1000	1500	2000	2200	2500	3000	3300	4000	4400	5000
	hp	14	29	43	58	64	72	87	96	116	128	145
	kg/hr	227	454	681	908	1000	1135	1362	1500	1816	2000	2270
	kW	146	292	438	584	644	730	876	966	1168	1287	1460
Boiler Length	A	1435	1985	2105	2630	2630	3110	3275	3580	4105	4330	4440
Overall Width	B	1250	1295	1625	1652	1885	2030	2130	2180	2310	2360	2720
Height to top of safety Valve	C	1485	1750	2125	2240	2350	2535	2735	2850	2925	3005	3280
Minimum height /chimney height	D	1340	1510	1870	1930	1990	2140	2340	2390	2515	2455	2870
Chimney Diameter ID	E	125	200	225	250	300	350	350	400	450	450	500
Tube Withdrawal Space	F	800	1220	1320	1800	2025	2425	2550	2835	2900	2900	3010
Base Frame Inset	G	280	450	450	500	500	580	650	650	825	825	825
Base Frame Length	H	1210	1400	1450	1800	1800	1620	1720	1930	2420	2420	2530
Base Frame Width	J	450	510	630	650	700	730	760	760	905	1010	1045
Steam Outlet	K	570	610	820	850	950	1020	1070	1100	1105	1140	1325
100psig	25NB	40NB	50NB	65NB	65NB	80NB	80NB	100NB	100NB	100NB	100NB	100NB
150psig	25NB	40NB	50NB	65NB	65NB	80NB	80NB	100NB	100NB	100NB	100NB	100NB
Safety Valve Outlet	100psig	11/4" BSP	11/4" BSP	11/4" BSP	11/2" BSP	11/2" BSP	2" BSP	2" BSP	21/2" BSP	21/2" BSP	21/2" BSP	3" BSP
Water Valve Outlet	150psig	11/4" BSP	11/4" BSP	11/4" BSP	11/2" BSP	11/2" BSP	2" BSP	2" BSP	21/2" BSP	21/2" BSP	21/2" BSP	3" BSP
Water Inlet	1" BSP	1" BSP	1" BSP	1" BSP	1" BSP	1" BSP	1" BSP	1" BSP	11/4" BSP	11/4" BSP	11/4" BSP	11/4" BSP
Blowdown Outlet	1" BSP	1" BSP	11/4" BSP	11/4" BSP	11/4" BSP	11/4" BSP	11/4" BSP	11/4" BSP	11/4" BSP	11/4" BSP	11/4" BSP	11/4" BSP
Burner Length*	mm	536	732	790	790	965	965	965	965	1155	1155	1155
Weight Empty	Kg	1100	1465	3105	3900	5100	6420	7220	7860	7990	8470	9430
Weight Full to NWL	Kg	1300	2030	3860	5265	6950	9660	10340	11575	11184	11990	13690
Total Heating Surface	m²	3.92	8.34	16.9	24.4	26.1	34.4	45.3				
Steam Release Area	m²	0.57	0.98	1.59	2.03	1.99	2.8	3				
Steam Space Volume	m³	0.05	0.1	0.28	0.35	0.26	0.47	0.52				

* Variable depending upon burner manufacturer
For illustration purposes only design drawings available upon request

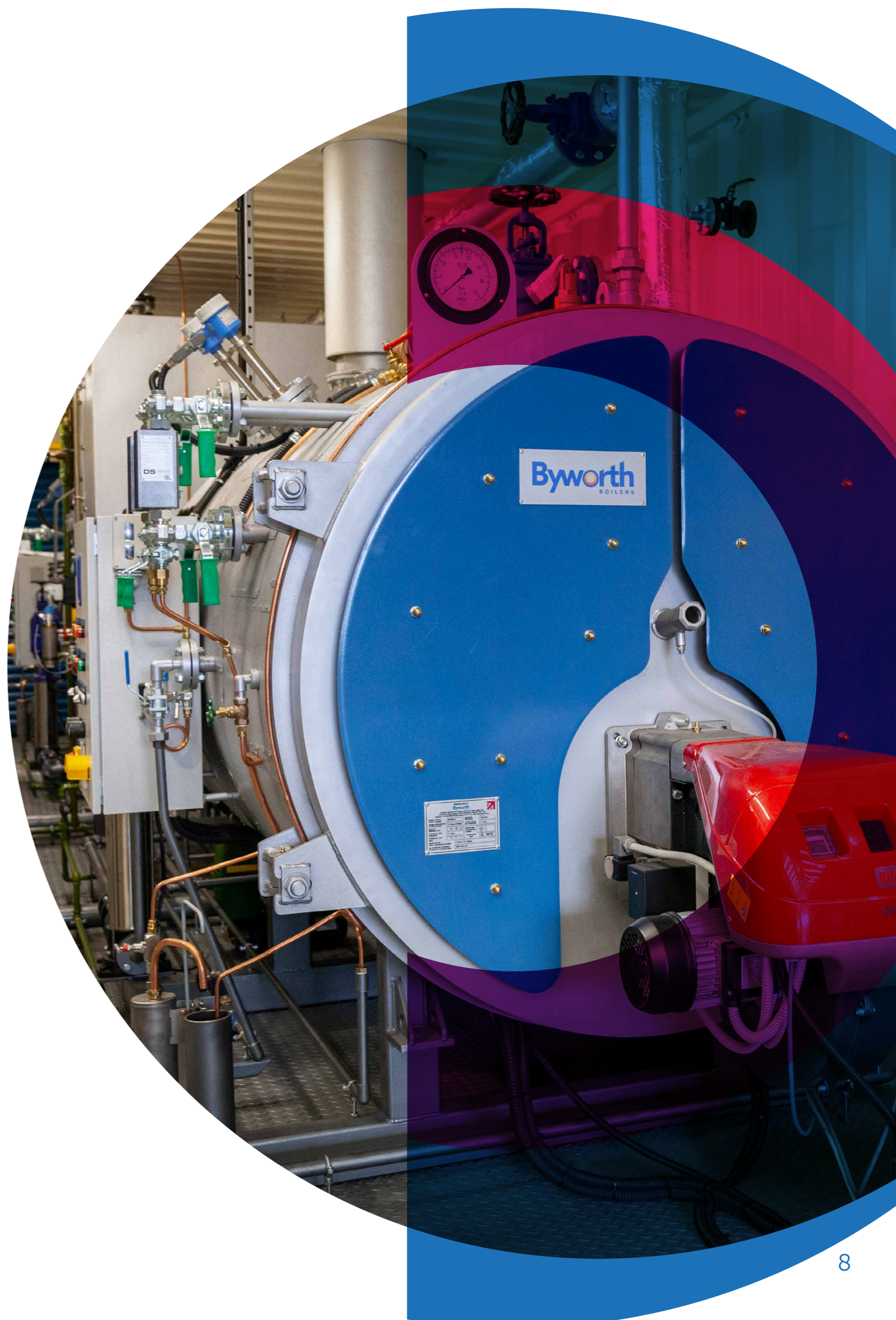

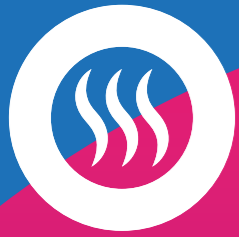

PEAKSMAN

A quality Byworth product, made in Britain

Sizes: 125 - 1000 kg/hr
Working pressure: 10.34 bar g (maximum)

With one of the smallest footprints in the industry the Byworth Peaksman boiler is the ideal steam solution for small to medium applications. Robust, reliable and designed for long-term ease of maintenance.

- Designed and manufactured in Britain
- Ultra low NOx (less than 40mg/m³ NOx when firing on Natural Gas)
- Modulating Controls
- 5-year guarantee (against manufacture defects for the vessel)
- Suitable to fire on Natural Gas or LPG
- Horizontally mounted burner for ease of maintenance and to reduce overall height



The Peaksman is all about providing the very best quality, British made steam solution within a small footprint.





The Peaksman Dimensions

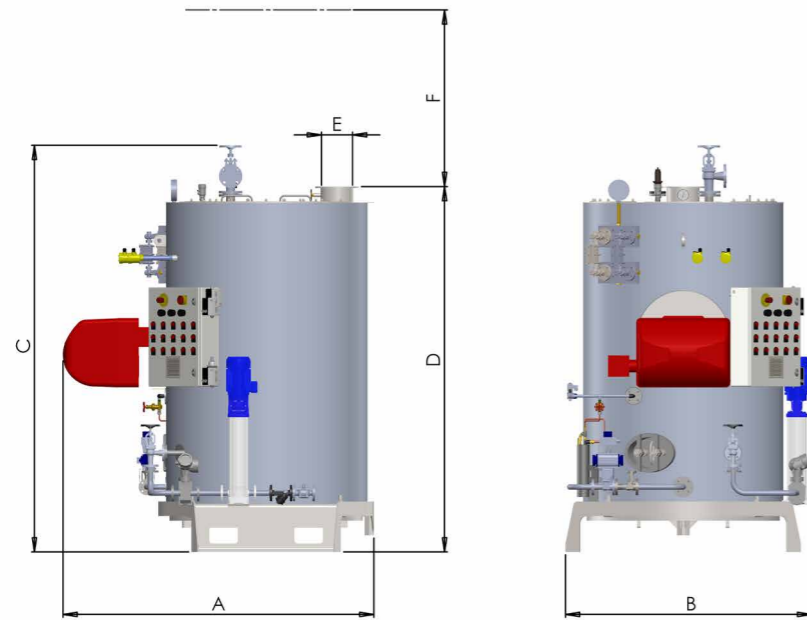

PEAKSMAN VERTICAL SERIES - BOILER DIMENSIONS

Model PSX		125	250	500	750	1000
Duty F & A 100°C	lb/hr	275	550	1100	1650	2200
	hp	8	16	32	48	64
	kg/hr	125	250	500	750	1000
	kW	78	157	313	470	627
Boiler Depth	A	1495		1775		2190
Overall Width	B	1200		1450		1740
Height to top of Crown Valve	C	2220		2600		2865
Minimum height /chimney height	D	1980		2350		2575
Chimney Diameter ID	E	125		150		225
Tube Withdrawal Space	F	1150		1520		1750
Transport Length*	G	2220*		2600*		2865*
Transport Width*	H	1090*		1350*		1650*
Transport Height*	J	980*		1250*		1550*
Steam Outlet	DN	DN25		DN40		DN50
Safety Valve Outlet	DN	DN25		DN25		DN25
Water Inlet	DN	DN25		DN25		DN25
Blowdown Outlet	DN	DN25		DN25		DN32
Transport Weight (stripped down)	Kg	1000		1600		2700
Weight Empty	Kg	1200		1800		3000
Weight Full to NWL	Kg	1560		2600		4370

* Transport measurements are based on boiler being laid on its back.
For illustration purposes only. Design drawing available upon request

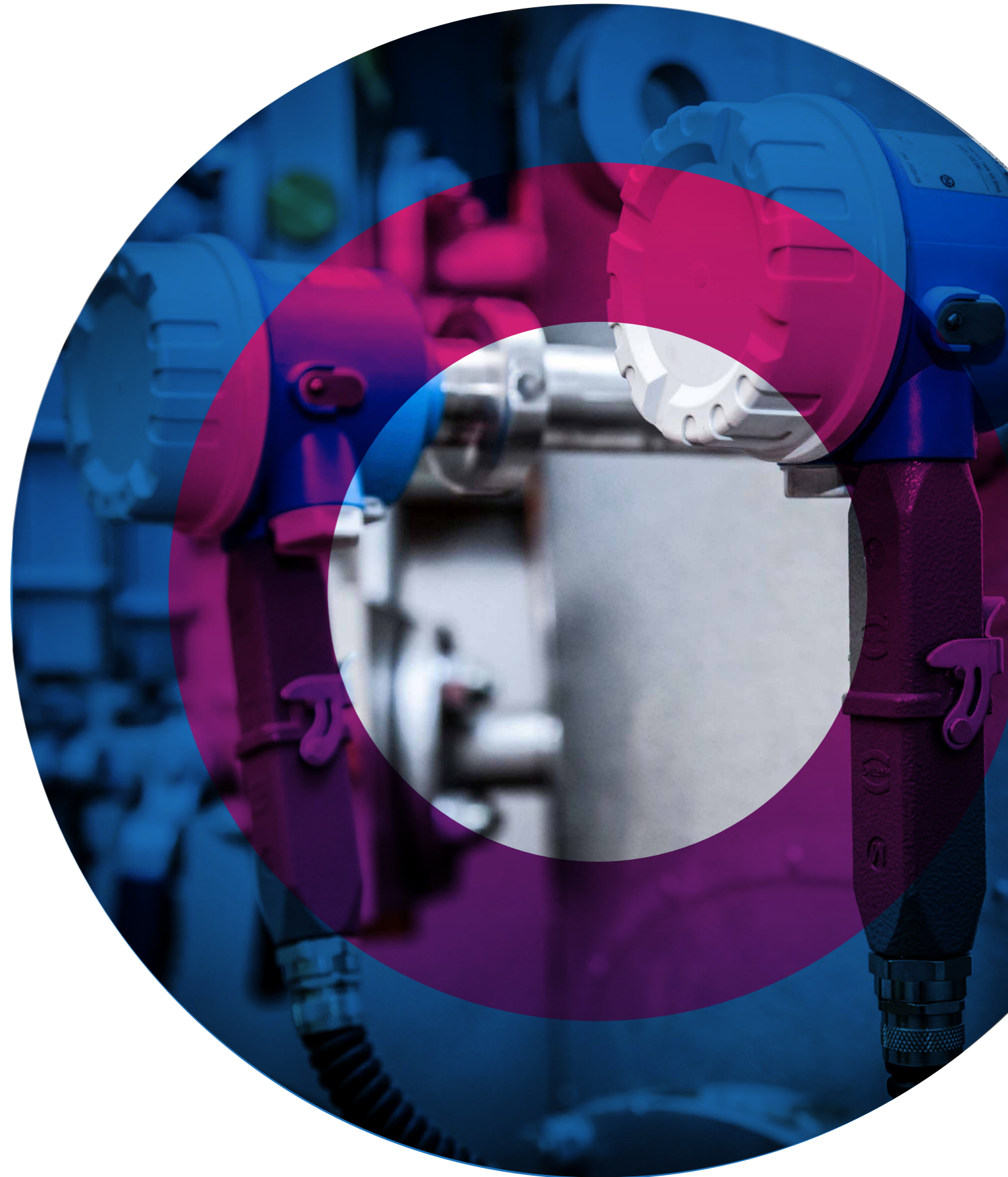



YORKSHIREMAN

The E-Series is a traditional three pass wetback
- Suited to medium to heavy steam load.

Sizes: from 1,100 to 19,000 kg/hr
Working pressure: up to 23 bar gauge

- High quality dry steam across a wide range of operating conditions thanks to the generous shell & furnace dimensions
- Thermal stresses are alleviated due to a central furnace
- Heat losses are minimised with high-density external insulation
- By using high-performance, ceramic materials we have eliminated problems associated with traditional refractory cement
- Faster NDT inspections as a result of multiple inspection ports, removable cladding panels, front & rear doors, as well as zero refractory on gas and light oil fired boilers
- Quality assured. Our internal inspection regime exceeds BS and EN requirements; this includes 100% ultrasonic inspections of all major welds
- Manufactured in Britain. All our boilers are individually built to customer requirements
- Our standard range includes all fittings necessary for a working boiler including a sample cooler and NDT inspection panels
- Optional extras for larger boilers include access ladders and gantries, available upon request

Eliminating the cracks

We only weld the heat transfer tubes at the hottest end to allow the tubes to expand and contract with the boiler, eliminating tube-end cracks that are typical of boilers with tubes fixed at both ends.



The E-Series Yorkshireman Dimensions

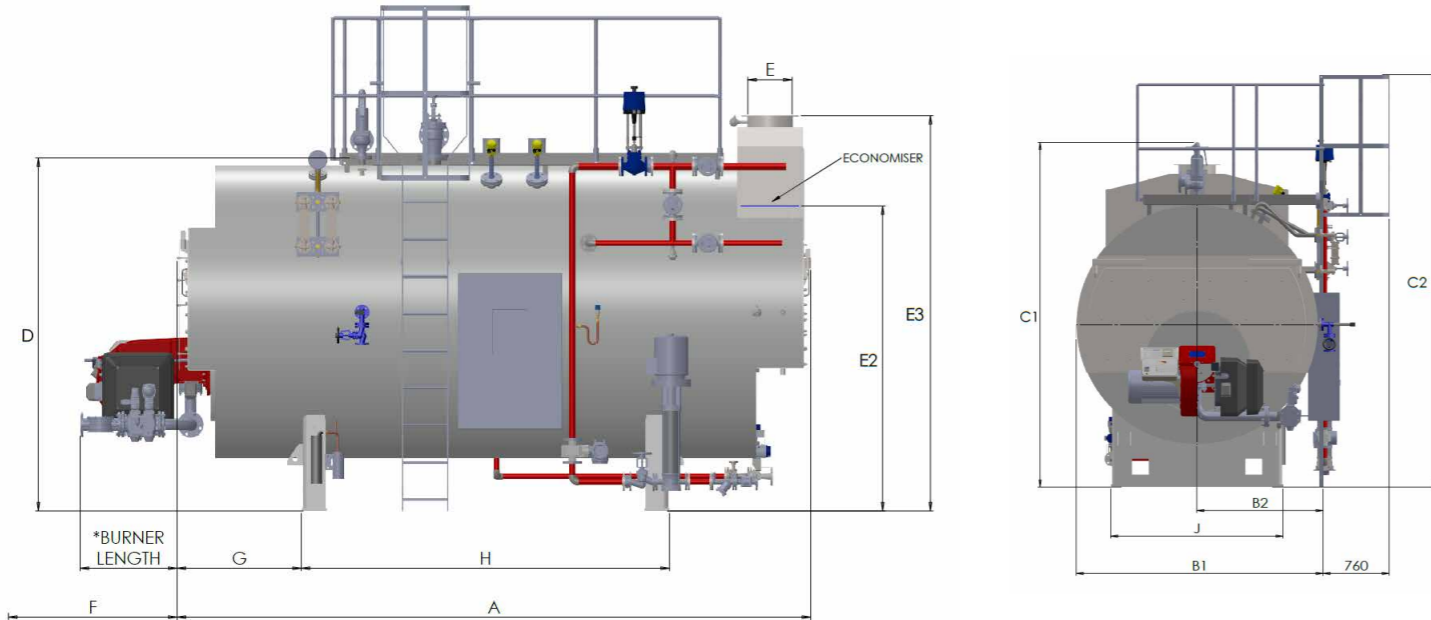

Model EYX		1100	1650	2400	3000	3500	4000	4600	5100	5700	6600	7800	9000	10000	11250	12000	14000	15000	16500	17500	19000
Duty F & A 100°C	lb/hr	2400	3600	5300	6600	7700	8800	10100	11200	12600	14600	17200	19800	22000	24800	26500	30900	33100	36400	38600	41900
	kg/hr	1100	1650	2400	3000	3500	4000	4600	5100	5700	6600	7800	9000	10000	11250	12000	14000	15000	16500	17500	19000
	kW	690	1034	1505	1881	2194	2508	2884	3197	3574	4138	4890	5642	6269	7053	7523	8777	9404	10345	10972	11912
	BoHP	70	104	154	191	223	255	293	325	365	423	499	574	638	719	768	896	959	1055	1119	1214
Overall Length	A	3126	3506	3767	4084	4258	4424	4707	5005	5042	5613	5666	5773	5799	6368	6412	6489	6597	6597	7671	7671
Overall Width	B	1780	2000	2125	2240	2310	2415	2490	2565	2620	2670	2826	3128	3245	3245	3340	3510	3665	3840	3875	3875
Overall Height	C	2280	2505	2693	3336	3457	3538	3740	3795	3895	3960	4142	4406	4570	4550	4750	4889	5024	5129	5164	5164
Minimum Height	D	1940	2115	2258	2336	2457	2538	2740	2795	2895	2960	3142	3406	3570	3550	3750	3889	4024	4129	4164	4164
Chimney Height	E	1660	1810	1873	1973	1975	2115	2245	2300	2350	2435	2444	2736	2740	2660	2724	2815	2925	3172	3720	3720
Chimney I/D	F	200	250	275	326	353	377	402	428	453	504	529	606	606	656	670	758	758	758	758	758
Tube Withdrawal	G	2220	2480	2660	2900	3010	3110	3350	3580	3570	4050	4030	4000	3970	4450	4430	4400	4400	4400	4330	5330
To End of Smokebox	H	167	207	231	237	257	277	287	307	322	337	357	387	417	436	461	487	487	487	559	559
To Baseframe Front	J	672	812	866	862	932	962	972	1032	1082	1122	1292	1332	1372	1446	1496	1522	1625	1222	1394	1394
Baseframe Length	K	1660	1760	1900	2170	2200	2300	2550	2720	2650	3100	2800	2780	2760	3150	3100	3100	2980	2920	4500	4500
Half Baseframe Width	L	450	500	550	625	635	700	725	750	800	825	875	925	975	1000	1050	1100	1170	1100	1300	1300
Mounting Plate	N	555	655	655	655	655	655	655	670	625	625	640	760	745	720	675	710	765	765	765	765
Burner Length*		1075	1255	1255	1255	1360	1360	1360	1360	1360	1409	1409	1409	1409	1409	1700	1700	1700	1700	1700	1700
Feed Pump - 150psi	DN	25	25	25	32	32	32	32	32	40	40	40	40	40	50	50	50	50	50	50	50
Crown Valve Outlet - 150psi	DN	50	65	80	80	100	100	125	125	125	125	150	150	150	200	200	200	200	200	200	200
Safety Valve Outlet - 150psi		1½"	1½"	1½"	2"	2"	2"	2½"	2½"	2½"	3"	3"	3"	3"	DN100	DN100	DN125	DN125	DN125	DN125	DN125
Blowdown Valve	DN	25	25	25	25	32	32	40	40	40	50	50	50	50	50	50	50	50	50	50	50
Weight Empty	kg	3210	4620	5900	6860	7860	8730	10210	11220	12030	14150	16530	20370	23100	25620	26665	27710	30310	34330	36590	42580
Weight to NWL	kg	5230	7400	9320	10930	12600	14160	16690	18520	20160	23670	27360	33420	37440	41560	43505	45450	50440	54820	59050	80195
Fuel Consumption of Natural Gas	m³/hr	78.7	116.9	169.6	210.3	242.9	276.7	316.9	349.1	390.4	448.3	529.8	609.3	677.5	757.8	808.5	944.8	1012.1	1113.3	1179.7	1286.6
Fuel Consumption of Natural Gas (with Economiser)	m³/hr	73.0	109.2	158.7	197.8	229.2	261.6	300.4	332.4	371.6	429.0	507.0	583.5	648.5	728.1	776.7	906.7	971.4	1068.5	1132.9	1232.0

For illustration purposes only design drawings available upon request
This chart relates to the EYX series boilers with working pressure up to 150 psi (10 bar). For higher working pressures please contact your local sales representative.
Some design features may change depending on the destination country





Heat Recovery Range

At Byworth we leverage our extensive expertise in efficient industrial heating solutions. Our heat recovery range is designed to achieve optimum performance given the heat available and the boiler output required.

Waste heat boilers can recover heat which is produced as a by-product of another process, turning heat that would otherwise be lost into useful steam or hot water.

As well as a range of single pass waste heat boilers to suit the most commonly available gas engines, Byworth are able to design bespoke waste heat boilers to suit other applications. All boilers are designed to achieve optimum performance given the heat available and the boiler output required.

Our waste heat recovery units are an ideal solution for fluid heating from gas turbine exhaust, internal combustion engine exhaust and process heat sources.

Byworth can also supply two pass, three pass, or composite boilers to meet specific customer and process requirements.

Composite boilers have a conventional fired section as the primary energy source, supplemented by waste heat when available. Alternatively, waste heat may be the primary source topped up by the burner when required.



Composite vs Single Pass Waste Heat

Composite boilers are sized to avoid problems often associated with more conventional CHP systems where the small, waste heat boiler is unable to cope with big swings in demand, therefore, requiring backup from often aged, conventionally fired boilers. The result is composites have less engine trips and improved steam quality.

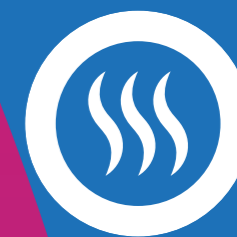

Economisers

Available as an integral, cartridge-type unit which is pre-piped and mounted to a new boiler or as a stand-alone unit.

Economisers and air preheaters are an easy way to maximise the efficiency of your combustion plant by recovering waste heat from the flue gases into the boiler feed water or combustion air.

Economisers

A typical economiser will reduce the flue gas temperature by between 70°C and 100°C, raising the feed water temperature by 20°C to 35°C in the process and saving between 4% and 6% on the cost of fuel.

Economisers are constructed from extended surface steel tubes in a steel casing with water flowing through the tubes while the hot gases pass over the outside. Cartridge-type economisers can be supplied with the M-Series and Yorkshireman boiler ranges at time of manufacture while external units are suitable for on-site installation and retrofit to existing boilers.



Solutions To Fit Your Environment

Packaged Boiler Housing and Energy Centres:

Options range from cost-effective skid mounted boilers and ancillaries through to purpose built pre-fabricated boiler houses.



Totally mobile

Larger boilers can be trailer mounted for use where steam or hot water is required remotely.





Skid-mounted Boiler

These packages save you time and money by having all interconnecting piping and wiring completed in our factory before despatch.

Built with the customer in mind, these ultra-compact, pre-assembled units are supplied with all the essential boiler accessories needed to make a complete system.

Skid mounted boiler contents:

- M-Series Boiler
- Hotwell tank with steam injection system
- Blowdown vessel with vent head
- Feed pump and isolation valve
- Single fuel high/low burner

Optional extras:

- Water softener
- Chemical dosing to suit site requirements

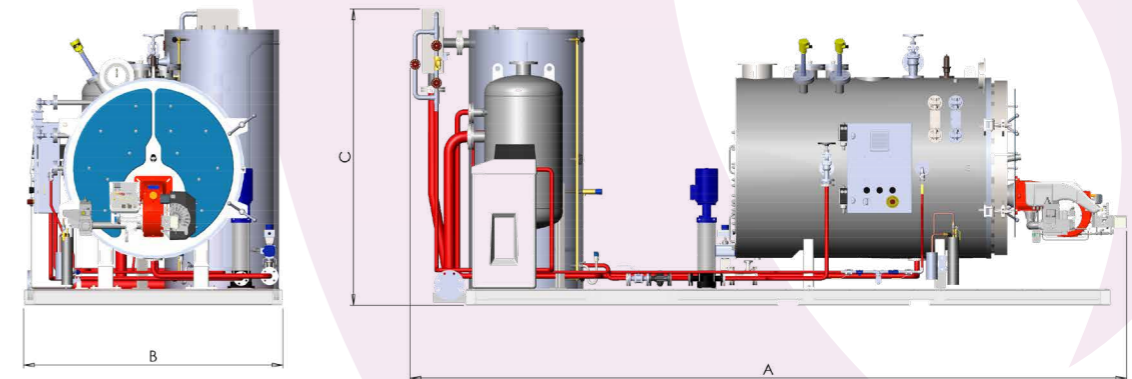

M-SERIES - Skid Package Dimensions

Model M-Series -Skid		250		500		1000		1360		
Duty F & A 100°C	lb/hr	500	550	1000	1100	1500	2000	2200	2500	3000
	hp	14	16	29	32	43	58	64	72	87
	kg/hr	227	250	454	500	681	908	1000	1135	1362
	kW	146	160	292	322	438	584	644	730	876
Skid Overall Length	A	3270		3765		5250		5250		
Skid Overall Width	B	1600		1600		2050		2050		
Approx. Overall Height	C	1550		2250		2300		2300		
Chimney Outlet Height		1340		1510		1870		1930		
Chimney Diameter ID		125		200		225		250		
Steam Outlet		25NB		40NB		50NB		65NB		
Safety Valve Outlet		11/4" BSP		11/4" BSP		11/4" BSP		11/2" BSP		
*Weight Empty (Shipping)	kg	1650		2250		4825		5650		
*Weight Full to NWL	kg	2500		3400		6400		8000		

*Approx. weight

For illustration purposes only design drawings available upon request





Pre-fabricated Boiler House

If you are looking for a modern self-contained energy centre, benefits include:

Innovation

A simple 'plug-and-play' solution significantly reduces on-site disruption

Sustainable approach

Reduce impact on the local environment – fewer resources on site, fewer site deliveries, less noise, less waste

Programme certainty

Constructed, pre-wired and tested to individual customer requirements prior to despatch, thus generating time-savings on-site

Flexibility

The asset can be moved and installed in other locations either on the same site or other sites providing future operational flexibility

Design for Life

40 year guarantee against corrosion and UV degradation in any normal outside environment (boiler house cladding only), with a time to first maintenance being circa 25-30 years for inland areas, ensures the longevity of the asset.

Boiler house contents:

- Steam boiler
- Blowdown tank
- Duplex water softener
- Chemical dosing
- Feed tank
- Fire detection
- Internal lighting
- Pre-piped and wired
- Water Treatment



The prefabricated boiler house is easily transportable with minimal onsite disruption during installation.

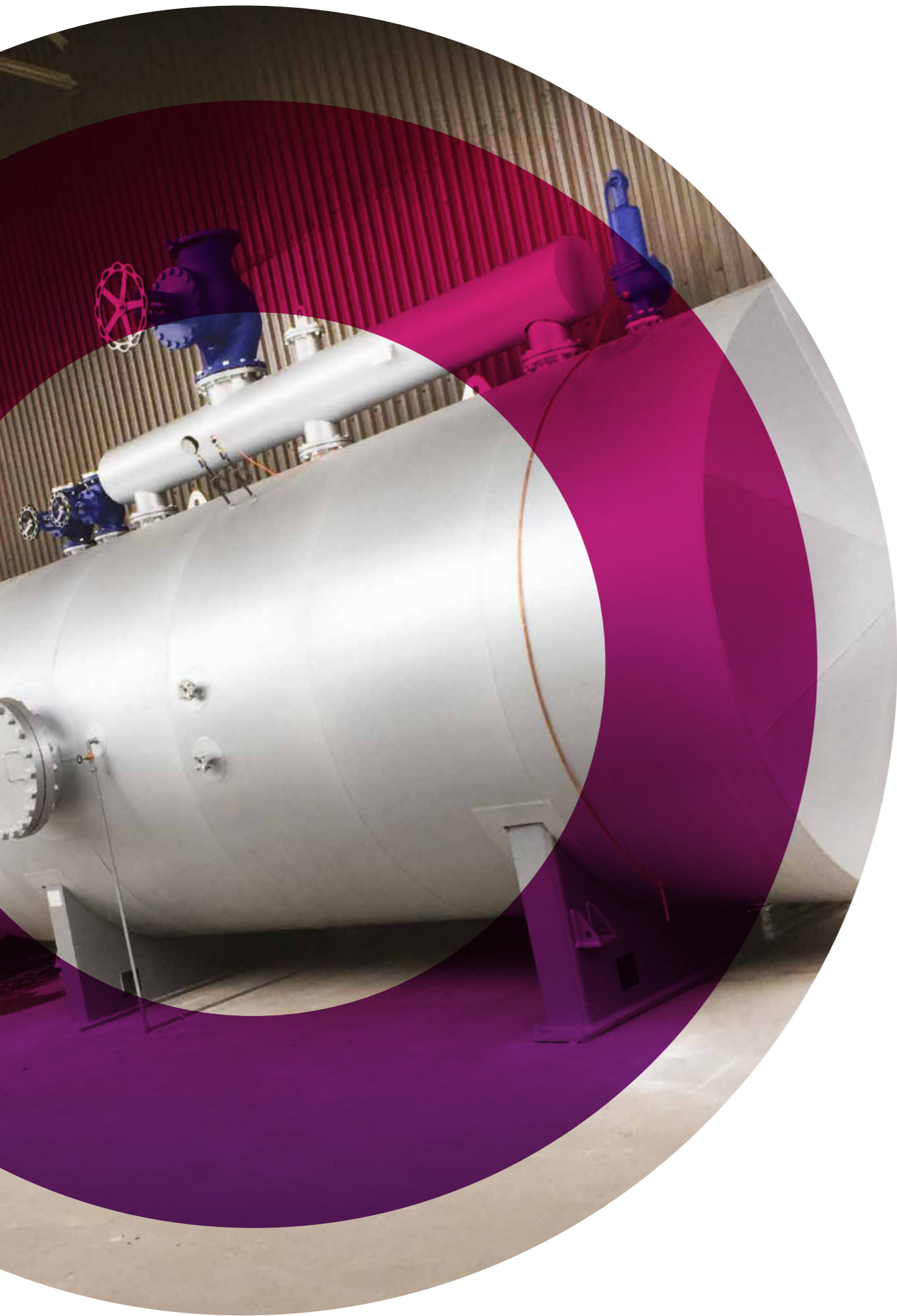

Steam Accumulators

Managing variable steam loads

While it is desirable to have combustion equipment with a high turn down in order to avoid excessive cycling and the resultant loss of efficiency, it is not advisable to operate boilers close to their minimum output for prolonged periods. Boilers are at their most efficient when operating around 70% of nameplate capacity, therefore, factories that experience highly variable steam demand would likely benefit from sizing boilers for their average load (instead of peak load) and incorporating a steam accumulator to smooth out the peaks and troughs in demand for steam.

Working Principle of Accumulators

When high-pressure, saturated water is exposed to low pressure, a percentage of this water will flash off into steam through using the remainder sensible heat in the water. The proportion of flash steam (kg of steam/kg of water) depends on the difference in pressure at which the hot water is exposed.

When plant experiences low steam demand, and the boiler can generate more steam than it needs (i.e. at maximum continuous rating of boiler), the unused, excess steam is injected into water that is stored under pressure inside the accumulator.

After some time, the temperature of stored water will increase to saturation temperature in line with the operating pressure of the boiler. When steam demand is high, in that it exceeds the maximum capacity of the boiler, it creates a drop in pressure in the accumulator which results in some of the water flashing into steam. Consequently, it can achieve the high steam demand without affecting the normal boiler operation.

Discharging of Accumulators

If the steam demand is higher than the boiler capacity, the pressure drops in the steam accumulator where the water is stored at saturation temperature. The pressure drop in the accumulator results in flash steam being generated, which offsets the high load requirement without effecting the normal boiler operation.

When the overload condition has stopped, it is subsequently followed by off-peak load, allowing excess steam to be injected into the accumulator. At this point, the accumulator will be ready to handle the next overload in demand. Consequently, the accumulator allows the boiler to achieve its preferred operating pressure and maximum efficiency.



Hotwell Tanks and Deaerators

The temperature of the water being fed to the boiler is of paramount importance.

Condensate contains around 25% of the energy of steam; so recovering as much condensate as possible is key to maximising operational efficiency.

These tanks are used to store recovered condensate and mix it with fresh make-up water, helping to drive off dissolved oxygen, reducing the need for chemical oxygen scavengers and improving boiler response time.

Tanks and deaerators are insulated to minimise heat losses. Various options are available from simple atmospheric tanks through to fully deaerated systems.

Recommended equipment available steam injection systems and semi or full deaerator heads.

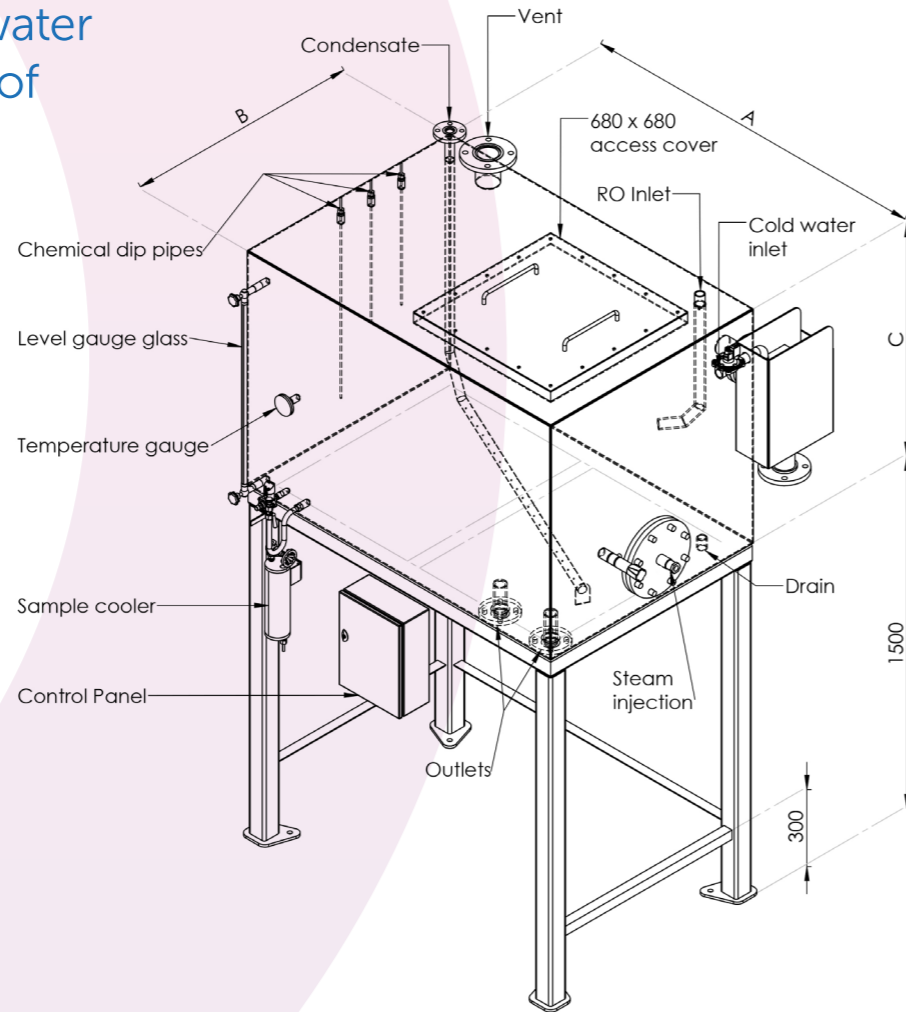

Capacity (ltrs)	0.56m ³	0.75m ³	1m ³	1.5m ³	2m ³	2.5m ³	3m ³	3.75m ³	4.5m ³	6.75m ³	7.5m ³	8m ³	9m ³	12m ³
A	1m	1m	1m	1.5m	2m	2.5m	2m	2.5m	3m	3m	3m	4m	4m	4m
B	0.75m	0.75m	1m	1m	1m	1m	1m	1m	1.5m	2.5m	2m	1.5m	1.5m	2m
C	0.75m	1m	1m	1m	1m	1m	1.5m	1.5m	1.5m	1.5m	1m	1m	1.5m	1.5m
Outlets	DN32	DN32	DN32	DN40	DN40	DN40	DN50	DN50	DN50	DN50	DN65	DN65	DN65	DN80
Overflow	DN65	DN65	DN65	DN65	DN65	DN65	DN65	DN100	DN100	DN100	DN100	DN100	DN100	DN100
Vent	DN50	DN50	DN50	DN80	DN80	DN80	DN100	DN100	DN100	DN100	DN100	DN100	DN100	DN100
Drain	1"	1"	1"	1"	1"	1"	1½"	1½"	1½"	1½"	1½"	2"	2"	2"
Inlets	1"	1"	1"	1"	1"	1"	1"	1½"	1½"	1½"	1½"	1½"	2"	2"
Condensate*	DN20	DN20	DN20	DN25	DN25	DN32	DN32	DN32	DN40	DN40	DN50	DN50	DN50	DN50

*Condensate subject to change (data based on 80% return).
For illustration purposes only. Design drawing available upon request





Blowdown Receivers

All steam boilers must be regularly blown down to reduce the concentration of suspended and dissolved solids in the boiler water.

As this waste is under pressure and at extreme temperature there must be a safe means of storage and cooling (to below 43 degrees C) before discharging to general drainage.

Byworth manufacture a range of blowdown vessels to suit a wide range of boilers.

Our tanks are deigned and built to PD5500 and meet the requirements of the Combustion Engineering Association's guidance document BG03.

Optional extras include vent heads, cooling water injection systems and multi-boiler manifolds.

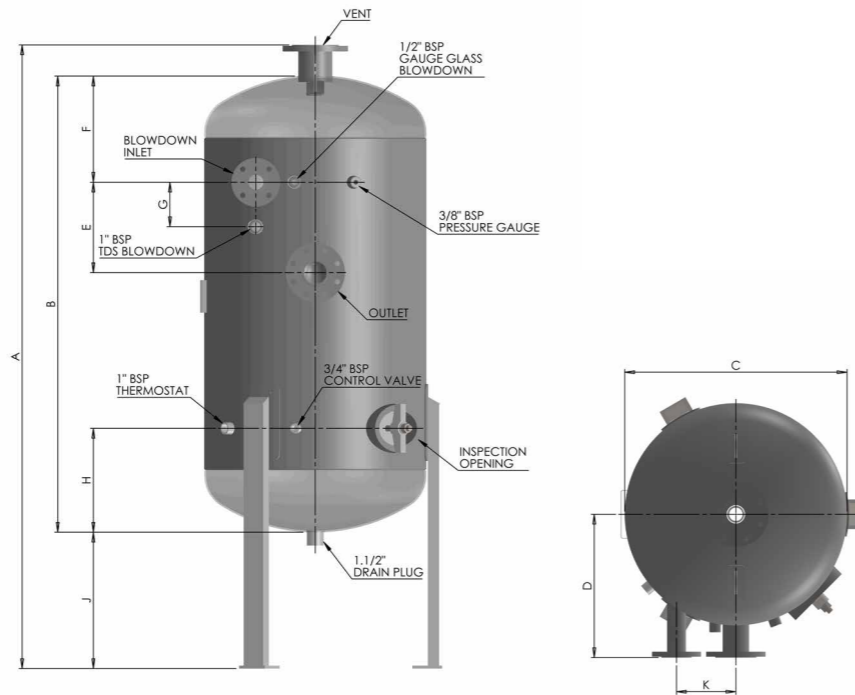

Model No.	A	B	C	D	E	F	G	H	J	K	Vent Size	Blowdown Inlet Size	Outlet Size	Inspection Opening Size	Approx. Weight (kg)
BT0	1365	808	393	290	160	201	120	218	458	120	DN80 3"	DN40 1.1/2"	DN50 2"	2" BSP Sight Hole	109
BT1	1760	1200	610	406	188	288	150	305	455	200	DN100 4"	DN50 2"	DN80 3"	180 x 120mm	210
BT2	2103	1538	749	483	305	358	150	350	460	200	DN100 4"	DN50 2"	DN80 3"	180 x 120mm	273
BT3	2312	1756	895	560	305	455	0	475	454	200	DN150 6"	DN50 2"	DN100 4"	320 x 220mm	402
BT4	2535	1981	1054	635	355	418	0	438	452	200	DN200 8"	DN50 2"	DN150 6"	320 x 220mm	635
BT5	2700	2143	1369	770	400	494	0	514	450	300	DN200 8"	DN50 2"	DN150 6"	320 x 220mm	850

All flange connections to BS EN1092:2003 PN16
For illustration purposes only. Design drawing available upon request





Parkwood Boiler Works
Parkwood Street
Keighley
West Yorkshire
BD21 4NW
United Kingdom
Tel: +44 (0)1535 665225
Email: sales@byworth.co.uk
byworth.co.uk